

REVO-E Series

Hybrid Energy Storage Inverter

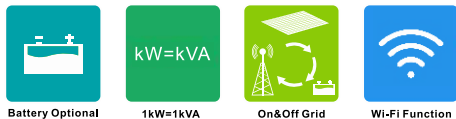

Product Snapshot

Model: 3-5.5kW
 Nominal Voltage: 220/230/240VAC
 Frequency Range: 50Hz/60Hz

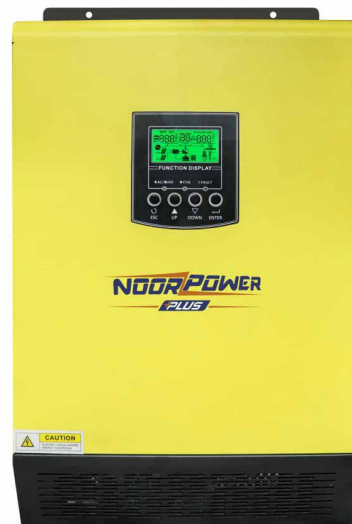

Hybrid Operation

With battery connected

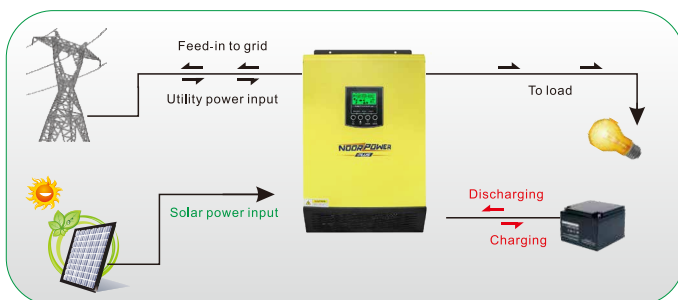

Without battery connected

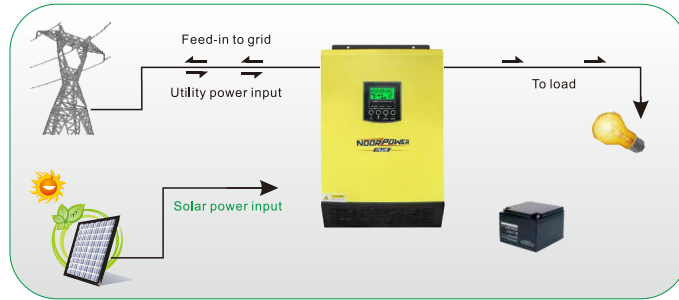

Key Features:

- Hybrid solar inverter(on/off grid inverter).
- Output power factor PF=1.0 .
- On-grid with energy storage .
- Configurable AC/Solar Charger priority via LCD setting .
- Smart battery charger design for optimized battery performance .
- Compatible to mains voltage or generator power .
- Overload ,Over temperature , Short circuit protection , Fault record ,History record .
- External WIFI devices .
- Parallel operation with up to 9 units .

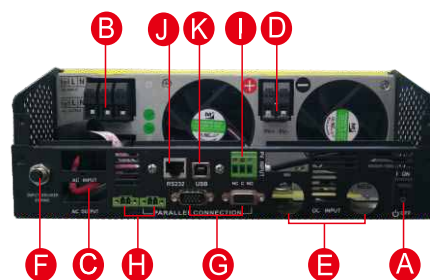

- A Power on/off switch
- B Grid connectors
- C AC output connectors (Load connection)
- D PV connectors
- E Battery connectors
- F Circuit breaker
- G Parallel communication cable
- H Current sharing cable
- I Dry contact
- J RS-232 communication port
- K USB communication port

■ Single phase output up to 49.5 KW using 9 units

■ Three phase output using either 3 units(16.5KW)or max 9 units(49.5KW)

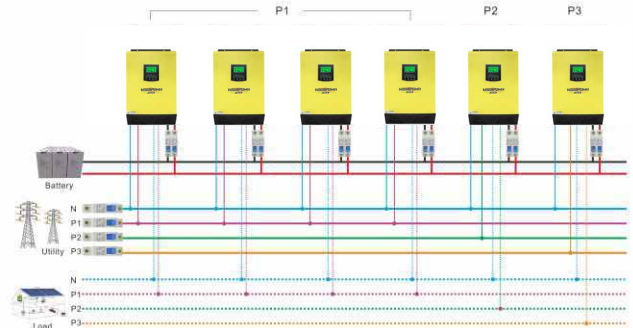
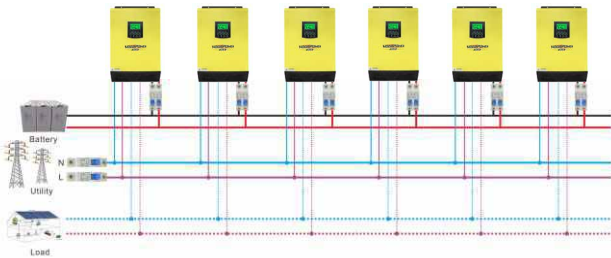

REVO-E Series

Wall Mounted Integrated Solar Power Inverter Technical Specification Built-in MPPT Solar Controller

MODEL	REVO E 3k-24	REVO E 3.2k-48	REVO E 5.5k-48
Max PV Array Power		5000W	
Rated Output Power	3000W	3200W	5500W
Maximum PV Array Open Circuit Voltage		500VDC	
MPPT Range @ Operating Voltage		120-450VDC	
GRID-TIE OPERATION			
GRID OUTPUT (AC)			
Nominal Output Voltage		220/230/240VAC	
Output Voltage Range		184-265VAC	
Nominal Output Current	13.6A/13.0A/12.5A	14.5A/13.9A/13.3A	25A/23.9A/22.9A
Efficiency		Up to 93.5%	
OFF-GRID, HYBRID OPERATION			
GRID INPUT			
Acceptable Input Voltage Range		120-280VAC	
Frequency Range		50Hz/60Hz (Auto sensing)	
BATTERY MODE OUTPUT (AC)			
Nominal Output Voltage		220/230/240VAC	
Output Wave form		Pure sine wave	
BATTERY & CHARGER			
Nominal DC Voltage	24VDC	48VDC	
Maximum Solar Charge Current		90A	
Maximum AC Charge Current		60A	
Maximum Charge Current		90A	
Emergency output power			
Maximum output Power	3000W	3200W	5500W
Surge Power	6000W	6400W	11000W
Automatic Transfer Time		<8ms	
GENERAL			
INTERFACE			
Parallel Function		Yes	
Communication		USB or RS232/Dry-Contact	
ENVIRONMENT			
Humidity		0~90% RH (No Condensing)	
Operating Temperature		0 to 50 °C	
Net Weight(KG)	10.35		11.35
Rough Weight(KG)	11.25		12.35
Dimension (W x D x H)mm		295x468.6x120.2	